

the **ēvō** system™

E16S V-SHELF BRACKET SPECIFICATION SHEET

MAX TOTAL WEIGHT 50 LBS / 22.67 KG

**VANTAGE
POINT**

Possibilities are mounting.™

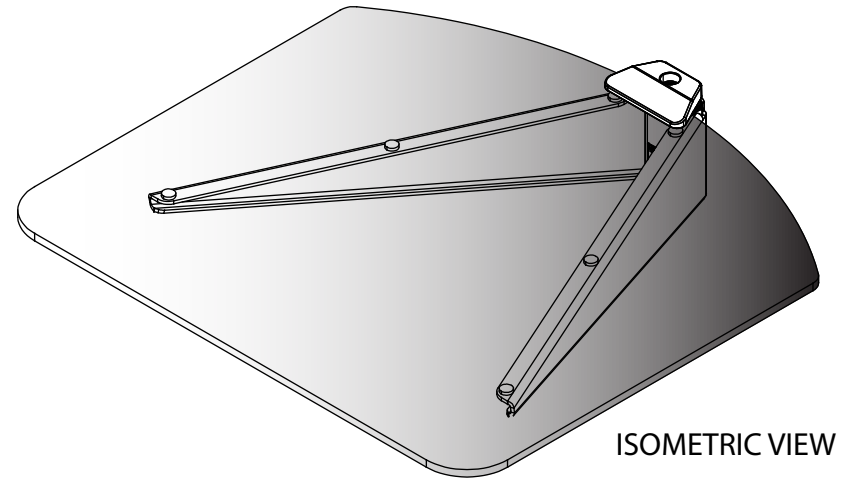
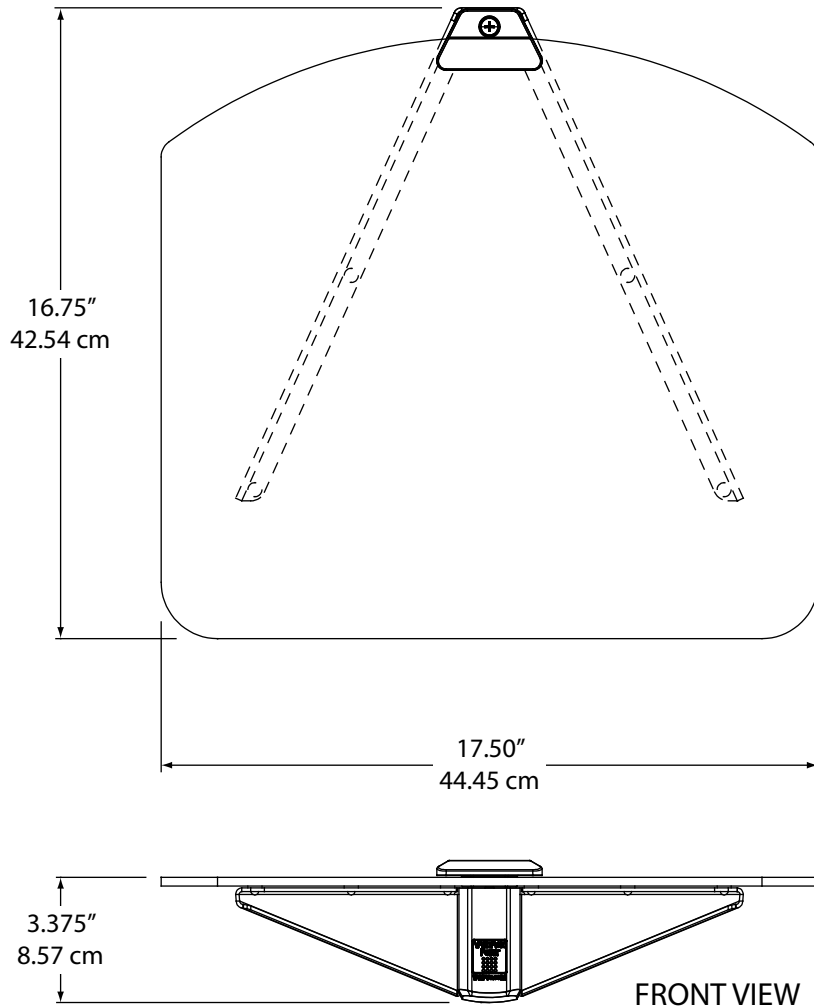

TOP VIEW

ISOMETRIC VIEW

FRONT VIEW

SIDE VIEW

Vantage Point Products Corp. 10233 Palm Drive Santa Fe Springs, CA 90670
USA: 800.582.9595 Canada: 905.607.9994 Europe: 31.72.581.6056
Email: cons-serv@vanptc.com Website: www.vanptc.com